

Before installation please ensure you have read the **Safe Swivel™ joint orientation** and **Operation and safety information**. This guide should be followed to ensure the **Swivelpole™** is assembled and installed safely and correctly.

Copies of general assembly drawings are available online www.swivelpole.com

Installation of Swivelpole™ S1, S2

1. Install the chosen mounting brackets to the stanchion or structure using either U-bolts or welds.
2. Ensure that the brackets are in-line.
3. Attach the pole base section to the brackets with the U-bolts supplied.
4. Rotate the Safe Swivel™ joint section to the desired orientation (see *Safe Swivel™ joint orientation*).
5. Align the base section so it is vertical.
6. Tighten U-bolts. A torque of 36 lb/ft is to be applied to all threads of the mounting brackets only.
7. The electrical cable can be routed through the pole top prior to bolting to the base section swivel plate.
8. **Apply multi-purpose grease to swivel plate surfaces and bolts.**
9. Slide the clamp plate onto the pole top.
10. With one person holding the pole top horizontally, the second person can position the round swivel plate locator into the hole of the base section swivel plate.
11. Bolt the clamp plate to the base section swivel plate, using the ½" UNC x 1½" HT galvanized hex head bolts with spring and flat washers.
12. The flange nuts are inserted on the underside of the base section swivel plate.
13. The safety pin wire loop should be fitted between the plates using the bottom left-hand bolt.
14. Tighten the bolts evenly.
15. Apply enough tension to allow controlled raising of the pole top.
16. At this point, the Swivelpole™ will be self supporting.
17. To raise, push the pole top, guiding it as it swivels to the upright position.
18. Insert the safety pin.
19. With the pole top in the upright position, mark the pole in the direction the luminaire is to face, and lower it again to fit luminaire mount.
20. To lower, retract the safety pin and swivel the pole top down to a safe working height and insert the safety pin.
21. Fit the luminaire mount as per marked position on the pole top.
22. When using non threaded poles and Swivelpole™ luminaire mount, tighten the set screws to a torque setting of 12 lb/ft to 15 lb/ft.
23. Complete installation and termination of the luminaire.
24. Raise the Swivelpole™ and insert the safety pin.
25. Tighten the bolts evenly to a torque setting of between 30 lb/ft and 60 lb/ft.

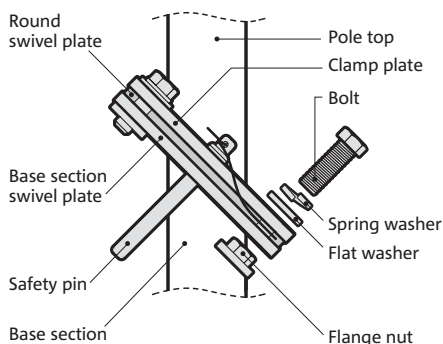
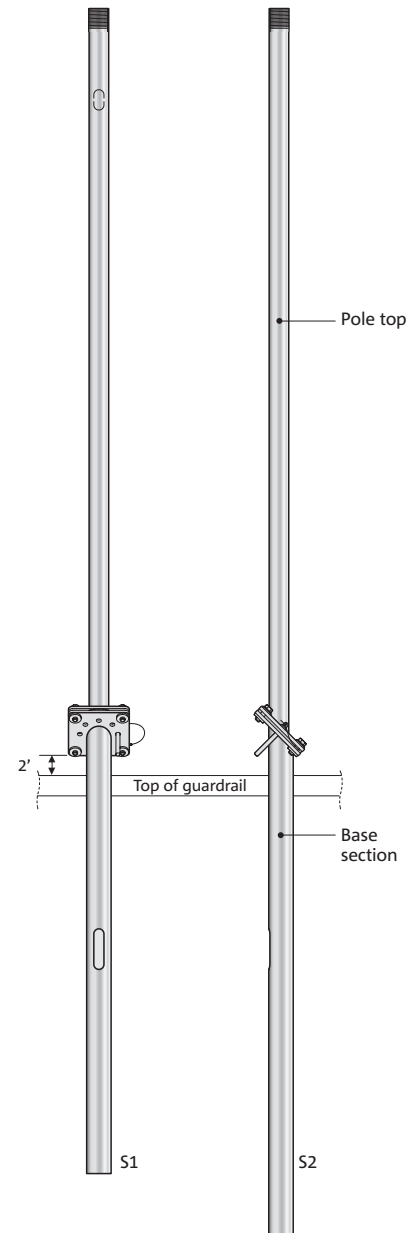

INSTALLATION & OPERATION GUIDE

Swivelpole™

The patented Swivelpole™ allows controlled lowering of the pole into a safe and comfortable working position. This guide should be followed to ensure the Swivelpole™ is assembled and installed safely and correctly so it works to its optimum performance.

This product must be installed in accordance with the applicable installation code by a person familiar with the construction and operation of the product and the hazards involved.

Ce produit doit être installé selon le code d'installation pertinent, par une personne qui connaît bien le produit et son fonctionnement ainsi que les risques inhérents.

Copies of general assembly drawings are available online
www.swivelpole.com



Safe Swivel™ joint orientation

Important: Safe Swivel™ joint allows clockwise or anti-clockwise orientation at any degree from the guardrail, with lowering operation to either side to avoid any clash to either side.

0° Safe Swivel™ joint orientation

Orientation avoiding clash behind the guardrail and to the right side.

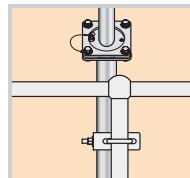
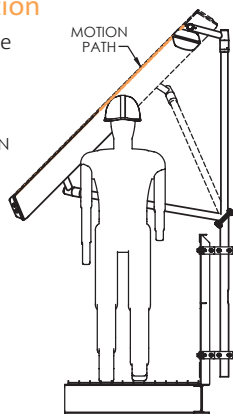
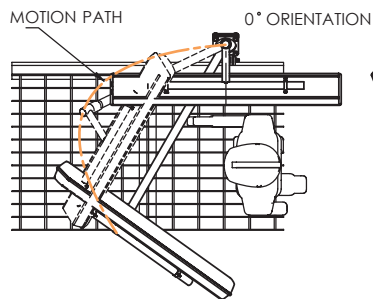

Stanchion mounted 0° orientation

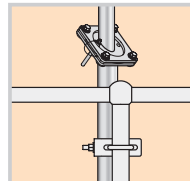

Stanchion mounted 45° anti-clockwise orientation

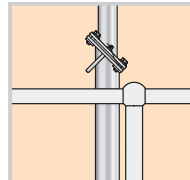

Structure mounted 90° anti-clockwise orientation

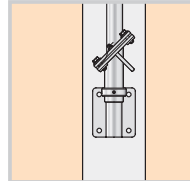

Column mounted 90° clockwise orientation

30° Safe Swivel™ joint orientation

Anti-clockwise orientation avoiding clash to the left side.

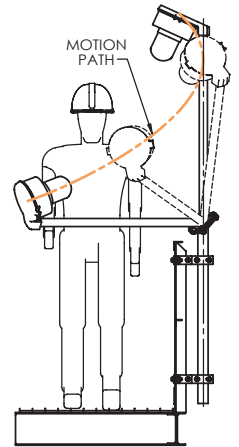
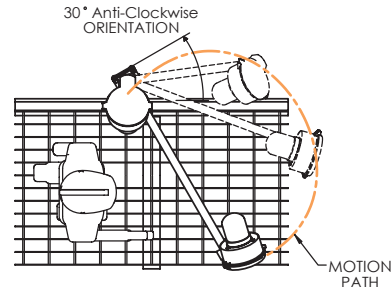

75° Safe Swivel™ joint orientation

Clockwise orientation avoiding clash behind the guardrail and to either side.

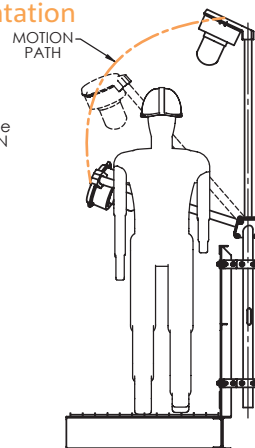
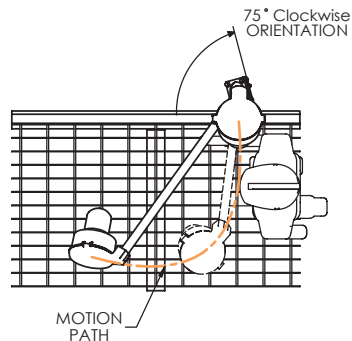

90° Safe Swivel™ joint orientation

Anti-clockwise orientation avoiding clash behind the guardrail and to the right side.

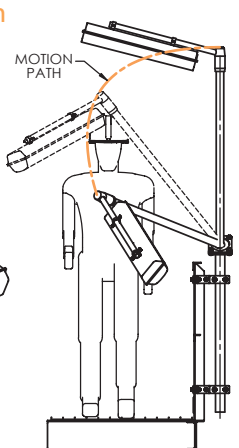
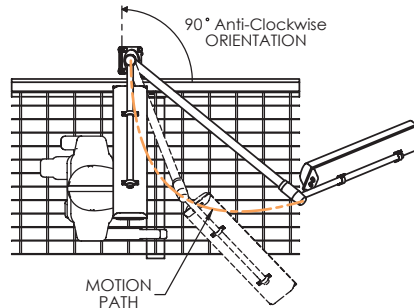

Operation and safety information

These guides are to be followed in conjunction with your worksite procedures, safety rules and regulations.

To lower Swivelpole™:

1. Ensure safety pin is inserted.
2. Loosen - **but do not remove** - bolts so the top section lowers with some resistance on the clamping plate. This allows safe and controlled lowering action for one-person operation.
3. Whilst holding the pole top with one hand, retract the safety pin and lower it to a comfortable working position.
4. Insert the safety pin.

To raise Swivelpole™:

1. Retract the safety pin.
2. Push the pole top, guiding it as it swivels to the upright position.
3. Insert the safety pin.
4. Tighten the bolts evenly to a torque setting of between 30 lb/ft and 60 lb/ft.

44lbs (20kg) recommended maximum fixture weight for one-person operation.

Tool and material requirements

Swivelpole™ assembly

- A torque wrench.
- Allen keys to suit: 3/16" set screws - use for light mounts. 3/8" or 1/2" set screws - use for Retrofit locking collars.
- Multi-purpose grease for Safe Swivel™ joint.

Maintenance and inspection

- Ensure the product operation label remains visible and legible.
- Visually check the Swivelpole™ for any signs of damage and report findings.

Customer Service

Swivelpole™

Email: sales@swivelpole.com

swivelpole.com

Product warranty. All equipment and goods are warranted by the seller to be free from defects in material and workmanship for five (5) years from the date of shipment. This warranty does not apply to equipment or goods which are misused, or abused, or damaged from installation, or not used in accordance with seller's instructions. Normal wear of equipment or goods is not included in this warranty. No responsibility will be taken for any modifications, alterations or additions to the standard product design. This includes exceeding recommended maximum weights for any fittings or exceeding the installed height.

Patented. Swivelpole™ products are manufactured under licence. Patents include US patent No. 6957832 and Australian patent No. 767949